

SECTION B-B

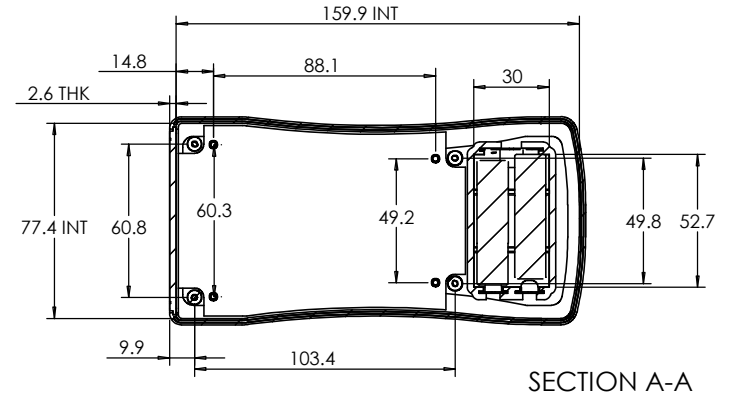

SECTION A-A

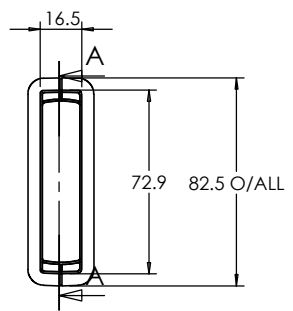
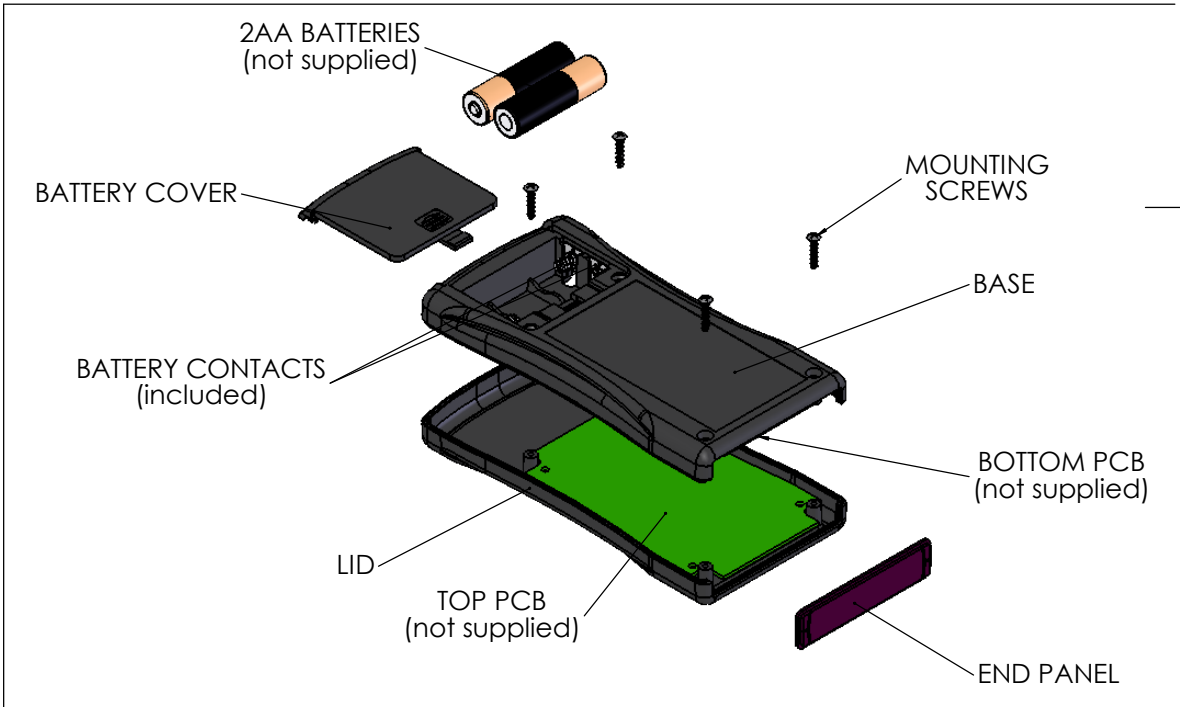
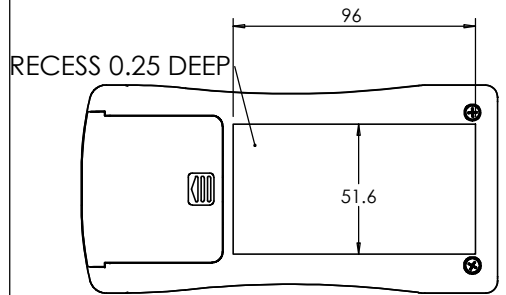
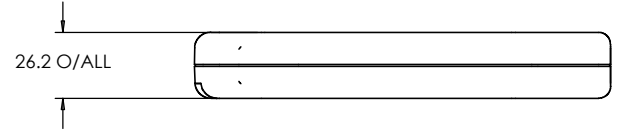

<p>CAMDENBOSS JAMES CARTER RD, MILDENHALL, SUFFOLK, IP28 7DE TEL: 01638 716101 FAX: 01638 716554 EMAIL: Sales@CamdenBoss.com WEB: www.CamdenBoss.com</p>		UNLESS OTHERWISE SPECIFIED: DIMENSIONS ARE IN MILLIMETERS	DO NOT SCALE DRAWING	REVISION. 0		
		FINISH: FINE TEXTURE SMOOTH LABEL RECESS	TITLE: GENERAL ASSEMBLY DRG FOR 45 SERIES PALM CASES			
DRAWN	NAME	SIGNED	DATE	MATERIAL: UL94-5VA ABS BLACK	DWG NO. CHH458ABK	A4
CHK'D	L.SUBHANKULOVA	LS	06/01/11	PROJECTION.	SCALE: 1 : 3	SHEET 1 OF 1

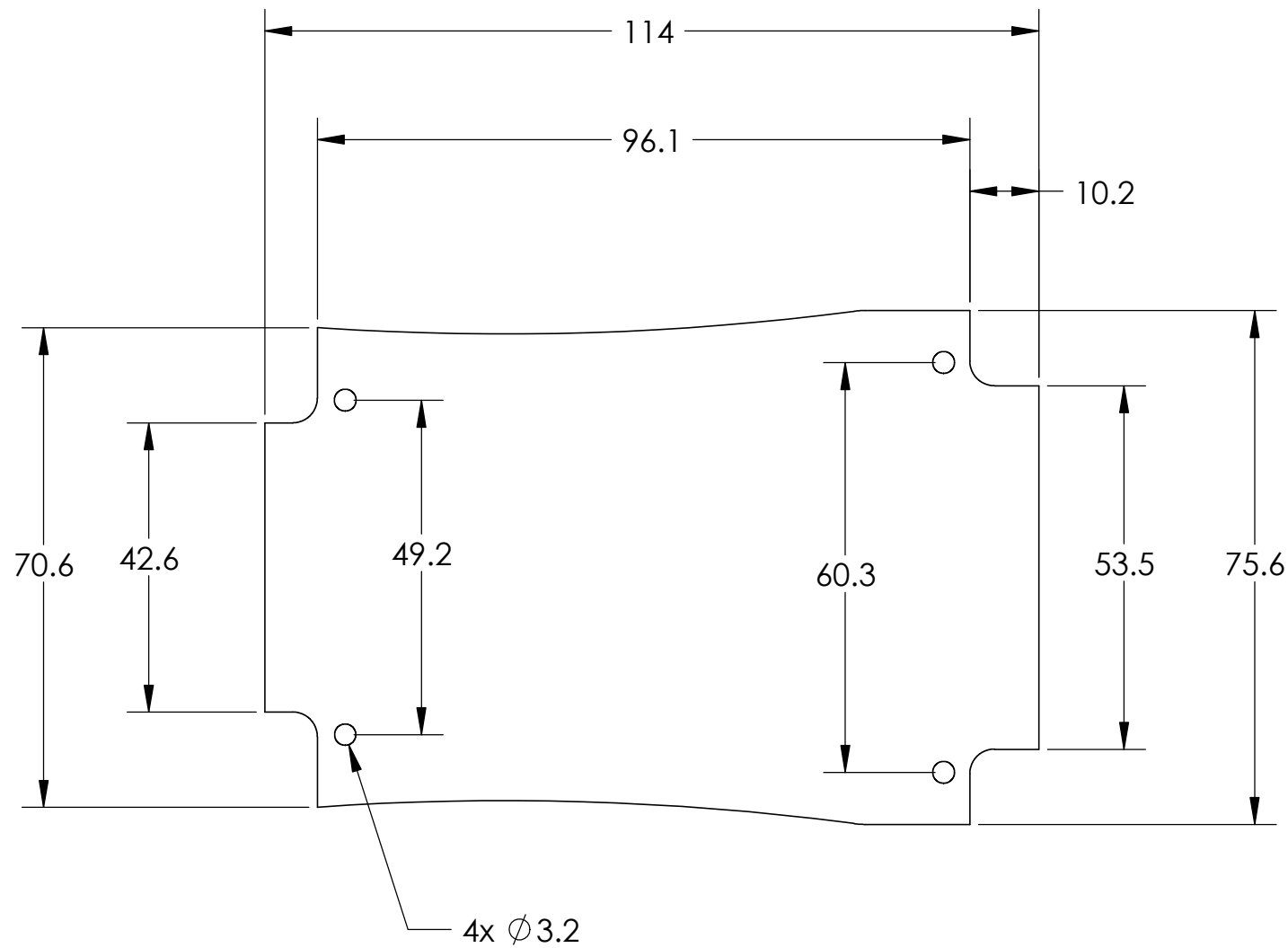

TOP PCB MOCK-UP

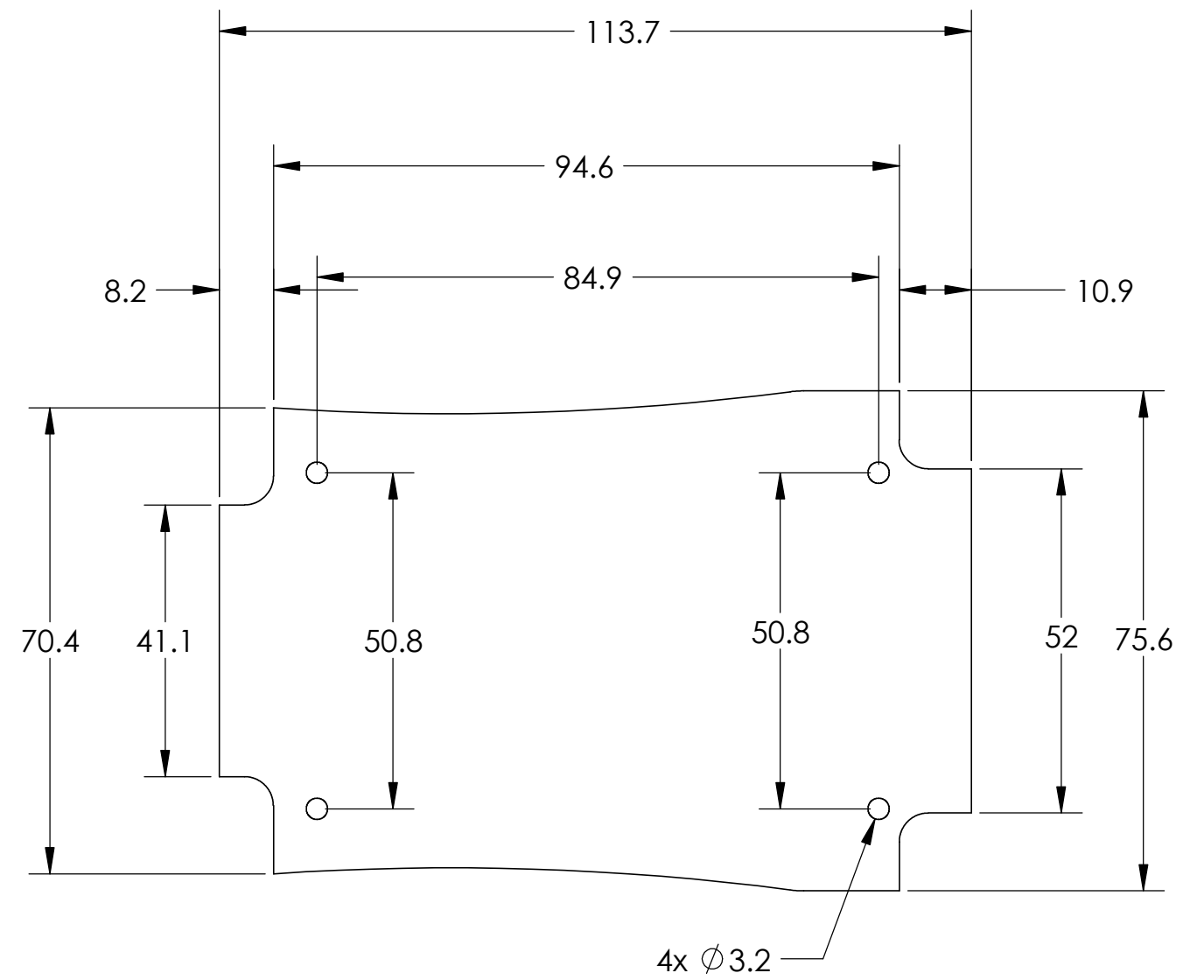

BOTTOM PCB MOCK-UP

CAMDENBOSS 60 JAMES CARTER RD MILDENHALL SUFFOLK. IP28 7DE EMAIL: SALES@CAMDENBOSS.COM WEB: WWW.CAMDENBOSS.COM TEL: 01638 716101 FAX: 01638 716554				UNLESS OTHERWISE SPECIFIED: DIMENSIONS ARE IN MILLIMETERS		DO NOT SCALE DRAWING	REVISION: 0
				FINISH: N/A		TITLE: PCB MOCK-UP DRG	
DRAWN: MATTHEW WALLACE		SIGNATURE: MJW		DATE: 06/01/11		MATERIAL: N/A	
CHK'D: L.SUBKHANKULOVA		SIGNATURE: LS		DATE: 06/01/11		PROJECTION:	
DWG NO. CHH458ABK PCB						A3	
SCALE: 1:1						SHEET 1 OF 1	

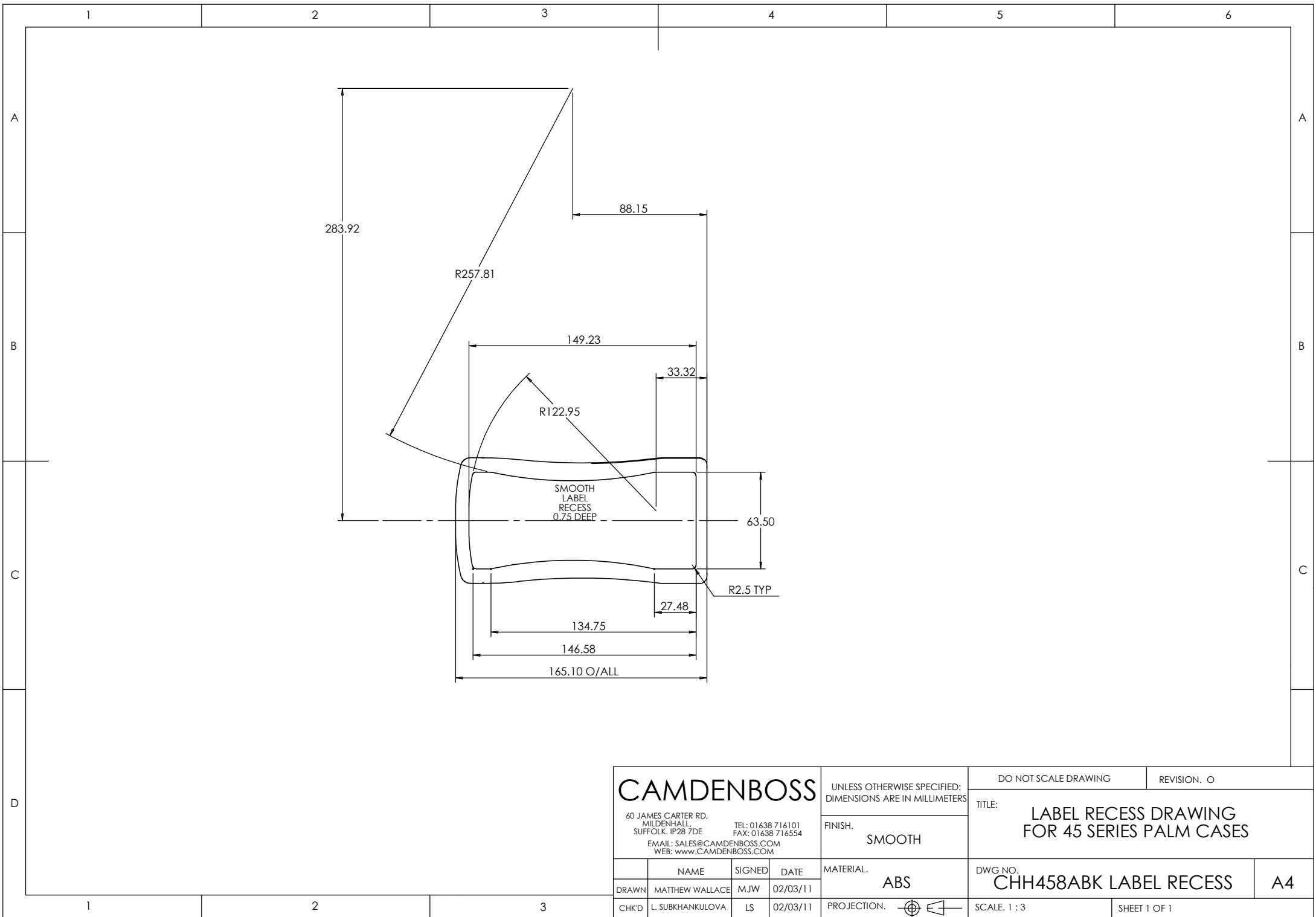

CAMDENBOSS

60 JAMES CARTER RD.
 MILDENHALL
 SUFFOLK. IP28 7DE
 TEL: 01638 716101
 FAX: 01638 716554
 EMAIL: SALES@CAMDENBOSS.COM
 WEB: WWW.CAMDENBOSS.COM

UNLESS OTHERWISE SPECIFIED:
 DIMENSIONS ARE IN MILLIMETERS

DO NOT SCALE DRAWING

REVISION. 0

FINISH.
 SMOOTH

TITLE:
 LABEL RECESS DRAWING
 FOR 45 SERIES PALM CASES

	NAME	SIGNED	DATE
DRAWN	MATTHEW WALLACE	MJW	02/03/11
CHK'D	L. SUBKHANKULOVA	LS	02/03/11

MATERIAL.
 ABS
 PROJECTION.

DWG NO.
 CHH458ABK LABEL RECESS
 SCALE: 1 : 3

A4