

THIS DOCUMENT IS THE PROPERTY OF
KEYSTONE ELECTRONICS CORP. AND
SHALL NOT BE REPRODUCED, DISTRIBUTED
OR USED AS A BASIS FOR MANUFACTURE
WITHOUT PRIOR WRITTEN PERMISSION
FROM KEYSTONE ELECTRONICS CORP.

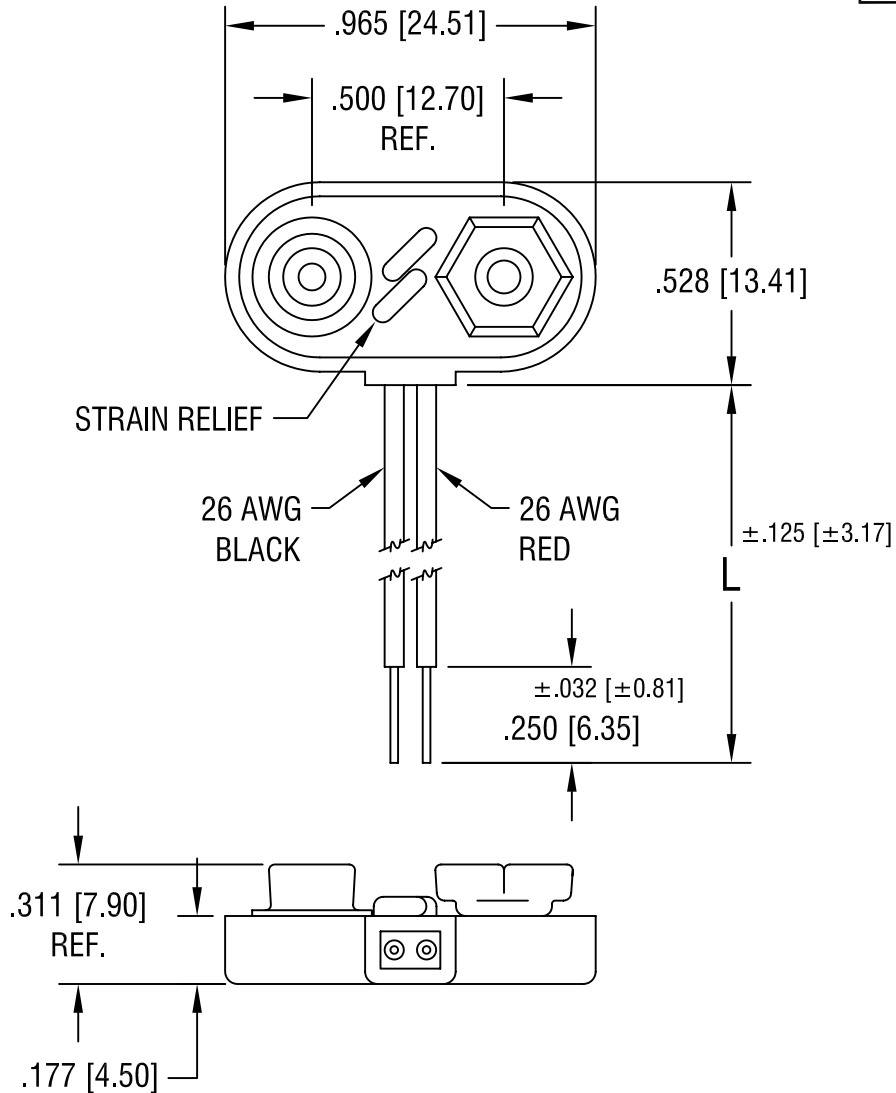

NOTE:

1. MAT'L:
WIRE: 26 AWG, 1007 UL/CSA APPROVED
CONTACTS: BRASS, NICKEL PLATE
COVER: MOLDED ABS
2. RED WIRE CONNECTED TO FEMALE CONTACT;
BLACK WIRE CONNECTED TO MALE CONTACT.

PART NO.	'L' DIM.
235-M	4.000 [101.60]
236-M	6.000 [152.40]
237-M	8.000 [203.20]

KEYSTONE ELECTRONICS CORP.

ASTORIA, N.Y. 11105-2017

PART NAME			
MOLDED ECONOMY '9' VOLT BATTERY STRAP			
MATERIAL			
AS NOTED			
FINISH		DRN BY	DATE
AS NOTED		BOONE	11.16.05
		APP'D	SCALE
			2X
TOLERANCES	INCH [MM]	CODE	DWG NO.
DECIMAL	± .020 [± 0.50]	C/M	235-M - 237-M
ANGULAR	± 1°		
UNLESS OTHERWISE SPECIFIED			

DATE	DESCRIPTION	REV.