

THIS DOCUMENT IS THE PROPERTY OF  
KEYSTONE ELECTRONICS CORP. AND  
SHALL NOT BE REPRODUCED, DISTRIBUTED  
OR USED AS A BASIS FOR MANUFACTURE  
WITHOUT PRIOR WRITTEN PERMISSION  
FROM KEYSTONE ELECTRONICS CORP.

**MOUNTING DETAIL**

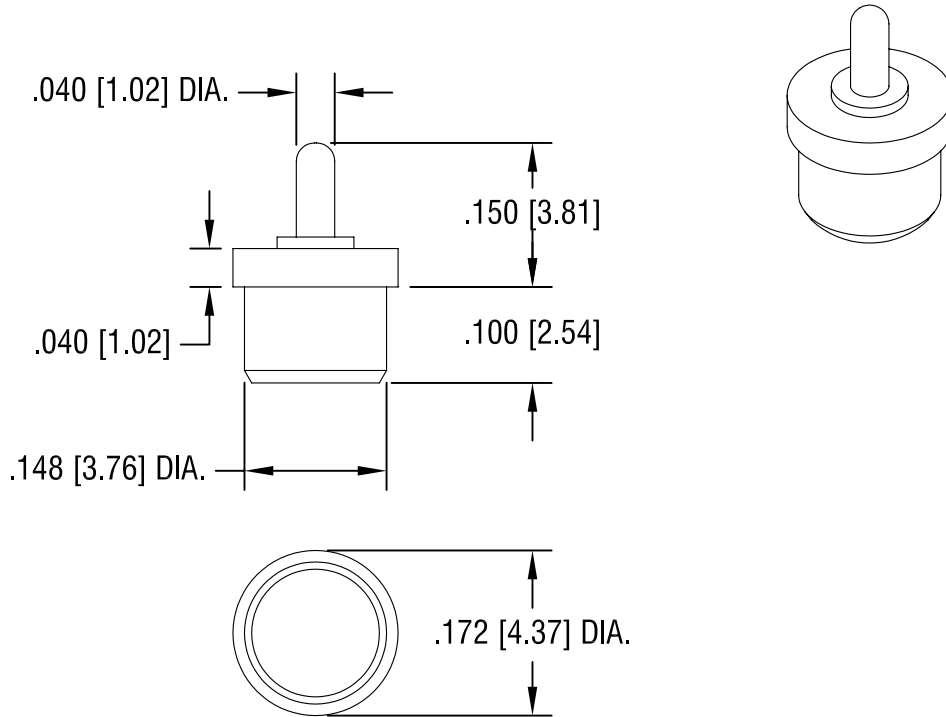
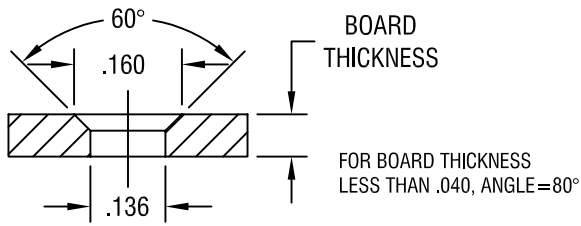

**NOTES:**

1. PIN: MAT'L - BRASS  
FINISH: TIN
2. BUSHING: MAT'L - PTFE (TEFLON)  
COLOR: WHITE

<b>KEYSTONE ELECTRONICS CORP.</b>			
ASTORIA, N.Y. 11105-2017			
PART NAME			
PTFE INSULATED TERMINAL			
MATERIAL			
AS NOTED			
FINISH		DRN BY	DATE
AS NOTED		N.T.	4.30.07
		APP'D	SCALE
			5X
TOLERANCES	INCH [MM]	CODE	DWG NO.
DECIMAL	± .005 [± 0.15]	C/M	<b>11067</b>
ANGULAR	± 1°		
UNLESS OTHERWISE SPECIFIED			

DATE	DESCRIPTION	REV.