

THIS DOCUMENT IS THE PROPERTY OF
KEYSTONE ELECTRONICS CORP. AND
SHALL NOT BE REPRODUCED, DISTRIBUTED
OR USED AS A BASIS FOR MANUFACTURE
WITHOUT PRIOR WRITTEN PERMISSION
FROM KEYSTONE ELECTRONICS CORP.

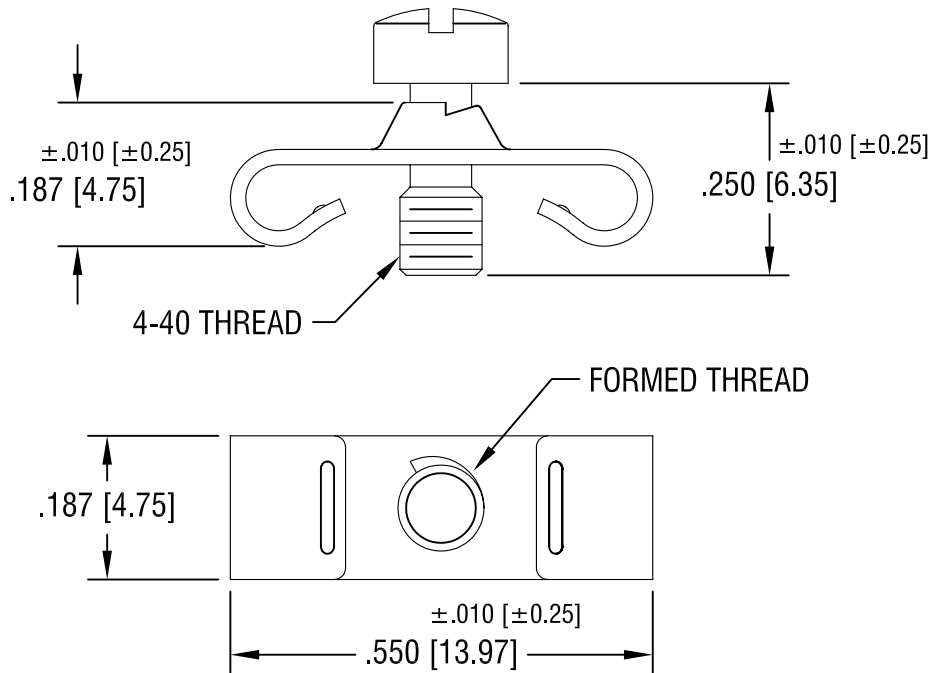
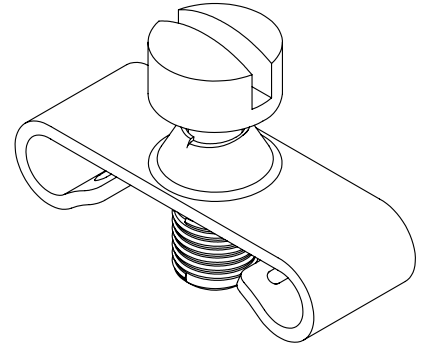

NOTES:

1. CLIP: .020 [0.50] SPRING STEEL
HEAT TREAT TO SPRING TEMPER
2. SCREW: STEEL
3. FINISH- ZINC PLATE, TRIVALENT
YELLOW CROMATE

9.10.08	CHANGE AS PER ECN 08-149	C
8.20.07	CHANGE AS PER ECN 07-047	B
7.18.05	CHANGE AS PER ECN 05-049	A
DATE	DESCRIPTION	REV.

KEYSTONE ELECTRONICS CORP.			
ASTORIA, N.Y. 11105-2017			
PART NAME			
'BOW TIE' RETAINING CLIP			
MATERIAL			
AS NOTED			
FINISH		DRN BY	DATE
AS NOTED		NT	1.7.00
		APP'D	SCALE
		LN	4X
TOLERANCES	INCH [MM]	CODE	DWG NO.
DECIMAL	± .005 [± 0.15]	C/M	2060
ANGULAR	± 1°		
UNLESS OTHERWISE SPECIFIED			