



SERIES 6425 - KEY SWITCHES

TO 100 mA 28 V



PRODUCT FEATURES

- Single-pole normally open contact with and without LEDs
- Pleasant actuating characteristic and low actuation noise
- Low bounce time
- Standard with gold plated contacts
- Wide range of key caps for different design requirements

ON REQUEST

- Customized key caps
- Other key cap colors
- Other LED colors
- Bicolor LED

Contact resistance (new condition)	< 250 mOhm
Insulation resistance (new condition)	> 100 MOhm
Bounce time	< 5 ms
Contact distance	< 3 mm
Ambient temperature	-20 °C ... +70 °C
Contact material	Au
Material actuator housing terminals	POM PBTP tinned
Terminal type	PCB terminal
Mechanical life endurance	1E6 at 10 mA 12 V
Flammability	UL 94 HB
Miscellaneous	The key base of the standard key can be snapped into a 1.2 mm thick frame with a cut-out of 13.55 x 13.55 mm. A current limiting to max. 20 mA must be provided for the integrated LED!

ROCKER SWITCHES

PUSHBUTTON SWITCHES

TOGGLE SWITCHES

SLIDE SWITCHES

ROTARY SWITCHES

FOOT SWITCHES

TACT AND KEY SWITCHES

SNAP-ACTION SWITCHES

MICRO-SIGNAL SWITCHES

SENSORS

ECO

PUSH/DRIVE



SERIES 6425 - KEY SWITCHES

TO 100 mA 28 V

- ROCKER SWITCHES
- PUSHBUTTON SWITCHES
- TOGGLE SWITCHES
- SLIDE SWITCHES
- ROTARY SWITCHES
- FOOT SWITCHES
- TACT AND KEY SWITCHES**
- SNAP-ACTION SWITCHES
- MICRO-SIGNAL SWITCHES
- SENSORS
- ECO
- PUSH/DOME

	100 mA 28 V	Color lamp	Pitch (mm)	Operating force (N)	Total travel / stroke (mm)	Miscellaneous	Stock version
Normally open contact (SPNO)							
6425.0101	○		> 16	0.7	1.4 ± 0.2	customer LED assembly possible	○
6425.1101	○		> 16	0.7	1.4 ± 0.2	narrow base for parallel guide	○
6425.3111	○		19	0.7	1.4 ± 0.2		○
6425.3121	○		19	0.7	1.4 ± 0.2		
6425.3131	○		19	0.7	1.4 ± 0.2		○
6425.4111	○		16	0.7	1.4 ± 0.2		○
6425.4121	○		16	0.7	1.4 ± 0.2		○
6425.4131	○		16	0.7	1.4 ± 0.2		○
6425.5111	○		16 + 19	0.7	1.4 ± 0.2	LED lower for button 834 900 ... and 835 900 ...	○
6425.5131	○		16 + 19	0.7	1.4 ± 0.2	LED lower for button 834 900 ... and 835 900 ...	○
6425.6111	○		> 15	0.7	1.4 ± 0.2	LED higher for key cap 827 ... 011	
6425.6131	○		> 15	0.7	1.4 ± 0.2	LED higher for key cap 827 ... 011	



Basic type 6425

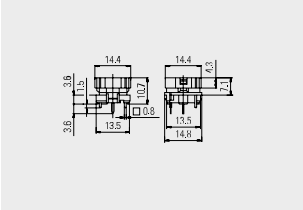

Without LED or customer LED assembly

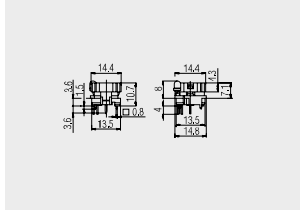

With LED

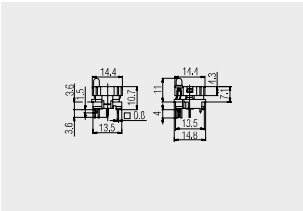

With LED for design key caps

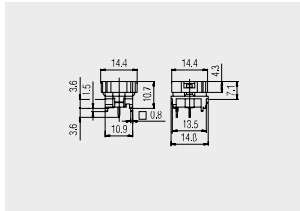

For multiple key caps with parallel guide



SERIES 6425 - KEY SWITCHES

TO 100 mA 28 V



Square key caps
pitch 16 mm

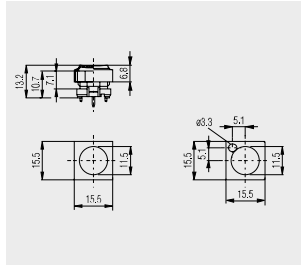

without LED window:
826.000.011 - anthracite
826.000.021 - dark gray
826.000.071 - red

with LED window:
829.000.011 - anthracite
829.000.021 - dark gray



Square key caps
pitch 19 mm

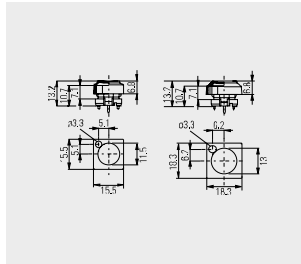

without LED window:
825.000.011 - anthracite

with LED window:
828.000.011 - anthracite
828.000.021 - dark gray



Round key caps

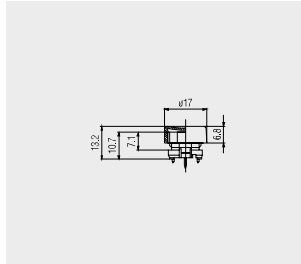

Key cap with ergonomic
actuation surface

840.000.011 - anthracite
840.000.021 - dark gray
840.000.071 - red



Design key caps

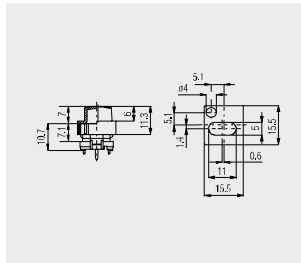

Key cap with oval actuation surface
pitch 16 mm

827.020.011 - anthracite
827.020.021 - dark gray

ROCKER SWITCHES

PUSHBUTTON SWITCHES

TOGGLE SWITCHES

SLIDE SWITCHES

ROTARY SWITCHES

FOOT SWITCHES

TACT AND KEY SWITCHES

NON-ACTION SWITCHES

MICRO-SWITCHES

SENSORS

ECO

PUSH/DRIVE



SERIES 6425 - KEY SWITCHES

TO 100 mA 28 V

ROCKER SWITCHES

PUSHBUTTON SWITCHES

TOGGLE SWITCHES

SLIDE SWITCHES

ROTARY SWITCHES

FOOT SWITCHES

TACT AND KEY SWITCHES

SNAP-ACTION SWITCHES

MICRO-SUBMINI SWITCHES

SENSORS

ECO

PUSH/DOME

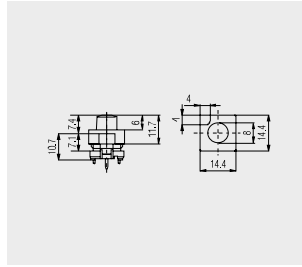

Design key caps

Key cap with round actuation surface
pitch ≥ 15 mm

- 827.100.011 - anthracite
- 827.100.021 - dark gray
- 827.100.031 - gray

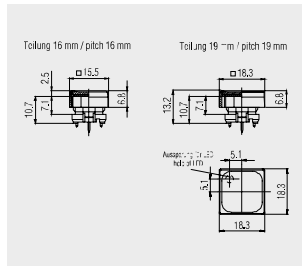

Key caps with transparent cap

Key cap anthracite
Cap transparent, enclosed loose
834.900.013 pitch 19 mm
835.900.013 pitch 16 mm
Two-part key cap with snap-on transparent caps, individual labeling and color possibilities can be implemented at low cost by a customer inlay.
For keys 6425.51xx with LED and 6425.0101 without LED.

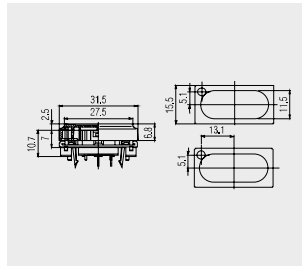

Double key caps
16 mm pitch

without LED window:
842.000.011 - anthracite
842.000.021 - dark gray

with one LED window:
842.500.011 - anthracite

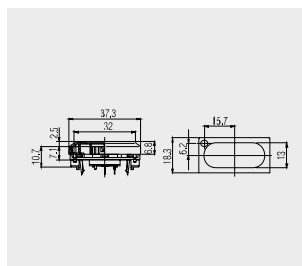

Double key caps
19 mm pitch

without LED window:
844.000.011 - anthracite

with one LED window:
844.500.011 - anthracite



SERIES 6425 - KEY SWITCHES

TO 100 mA 28 V



Triple key caps

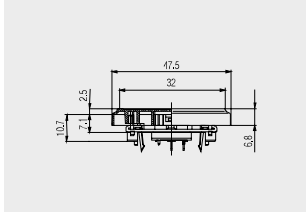

843.000.011 - anthracite
pitch 16 mm

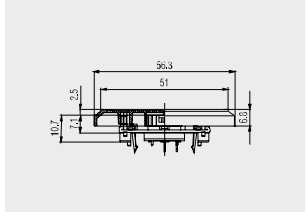

845.000.011 - anthracite
pitch 19 mm



Parallel guide

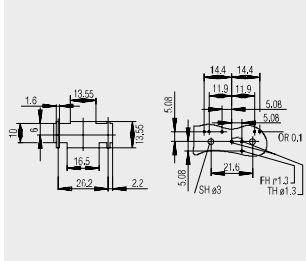

190.059.013
Recommended appliance cut-out and perforation pattern component side parallel guide for:
double key caps, pitch 16 mm

190.059.013
Recommended appliance cut-out and perforation pattern component side parallel guide for:
double key caps, pitch 16 mm

The parallel guide guarantees an optimum function even in case of off-center actuation and can be equipped additionally with one or two LEDs.



Parallel guide

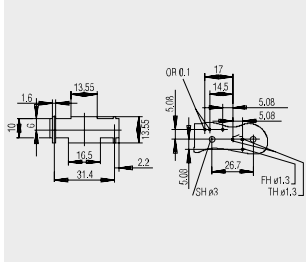

190.059.023
Recommended appliance cut-out and perforation pattern component side parallel guide for:
triple key caps, pitch 16 mm
double key caps, pitch 19 mm
triple key caps, pitch 19 mm

The parallel guide can be equipped additionally with a LED.

190.059.023
Recommended appliance cut-out and perforation pattern component side parallel guide for:
triple key caps, pitch 16 mm
double key caps, pitch 19 mm
triple key caps, pitch 19 mm

The parallel guide can be equipped additionally with a LED.

- ROCKER SWITCHES
- PUSHBUTTON SWITCHES
- TOGGLE SWITCHES
- SLIDE SWITCHES
- ROTARY SWITCHES
- FOOT SWITCHES
- TACT AND KEY SWITCHES
- SNAP-ACTION SWITCHES
- MICRO-SIGNAL SWITCHES
- SENSORS
- ECO
- PUSH/DRIVE



SERIES 6425 - KEY SWITCHES

TO 100 mA 28 V

- ROCKER SWITCHES
- PUSHBUTTON SWITCHES
- TOGGLE SWITCHES
- SLIDE SWITCHES
- ROTARY SWITCHES
- FOOT SWITCHES
- TACT AND KEY SWITCHES**
- SNAP-ACTION SWITCHES
- MICRO-SIGNAL SWITCHES
- SENSORS
- ECO
- PUSH/DOME

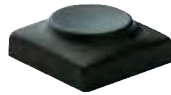









































Square key caps with white characters

Please complete the reference numbers by the three figures below the respective character.

Basic reference numbers for pitch 16 mm:
826 ... 011 - anthracite

Other key cap colors and characters on request.

					
051	052	053	054	055	056
					
057	058	059	060	061	062
					
063	064	065	066	067	068
					
069	070	071	072	073	074
					
075	076				
					
017	018	022	023	170	
					
010	001	002	003	004	
					
005	006	007	008	009	